

Terrano™ XT

MANUAL



For easy reference while on the road, download the Pocket Guide from terranosystems.com/support/.

This is version 1.0 of the TERRANO XT Manual. The latest version of the manual in your preferred language and various tutorials can be found at terranosystems.com/support/.

CONTENTS

1. Introduction	4
2. Charging the TERRANO XT	5
3. Getting Started	6
3.1 Getting to Know Your TERRANO XT	6
3.2 Switching Your Unit On/Off	6
3.3 Different Ways to Operate Your TERRANO XT	6
3.4 Basic Functions	7
3.5 Pairing Your Unit to Bluetooth Devices	7
4. On the Road	9
4.1 Making and Receiving Phone Calls	9
4.1.1 Making Phone Calls	9
4.1.2 Answering Phone Calls	9
4.1.3 Rejecting Phone Calls	9
4.1.4 Ending Phone Calls	9
4.1.5 Toggling Between Calls on Two Mobile Phones Paired to Your Unit	9
4.1.6 Disconnecting the Current Call and Switching To the Second Call	9
4.2 Bluetooth Intercom	10
4.2.1 Pairing the Bluetooth Intercom to other Terrano Units	10
4.2.2 3-Way and 4-Way Bluetooth Intercom Calls	10
4.2.3 Using the Bluetooth Intercom	11
4.3 Listening to Music and Radio	13
4.3.1 Listening to Music	13
4.3.2 Listening to FM Radio	14
4.3.3 Sharing Music and Radio	15
5. Personalizing Your Device	16
5.1 Setting the Default Mobile Phone	17
5.2 Using Parallel Audio Streaming	17
5.3 Audio Source Priorities	18
6. Troubleshooting	19
6.1 Soft Reset	19
6.2 Reset Pairing	19
6.3 Reset to Factory Settings	19
6.4 FAQ	19
7. Support	20
8. Glossary	21
Appendix A. TERRANO XT Modes and Events - LED Indications	22

1. INTRODUCTION

Thank you for choosing the TERRANO XT Bluetooth® communication system for bicycle helmets.

This manual describes the features of your TERRANO XT and how to use them.

We wish you a great TERRANO XT experience and encourage you to write to us at support@terranosystems.com regarding any questions, suggestions or comments you may have.

If you have not yet installed the TERRANO XT unit in your helmet, please install it as described in the Installation Guide provided in the package.

2. CHARGING THE TERRANO XT

Make sure that your TERRANO XT battery is charged for at least 4 hours before initial use.

To charge the TERRANO XT:

- Using the supplied USB cable, connect your computer or wall charger to the TERRANO XT USB port.

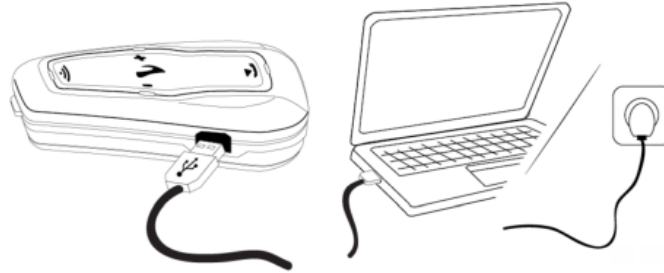

- Charging with the wall charger is faster than via a computer USB port.
- Charging your unit switches it off automatically. To use your unit while it is being charged, switch it on. (see [Switching Your Unit On/Off](#) on page 6).
- You can charge the unit while riding using a power bank.

During charging, the LED indicates charging status as follows:

- Red LED on - charging
- Red LED off - charging complete

If the battery level reaches 20%, a battery status voice announcement warns you that your battery is low.

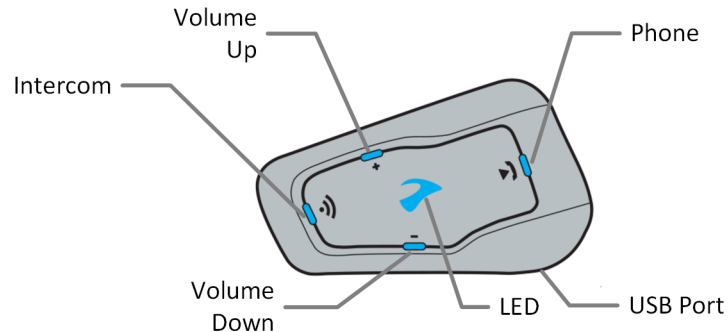

3. GETTING STARTED

3.1 GETTING TO KNOW YOUR TERRANO XT



3.2 SWITCHING YOUR UNIT ON/OFF



To switch your unit on:

- Press  and  for 1 second. 

The speaker plays an ascending tone and a voice message "Hello TERRANO XT".

In all battery states, the LED flashes blue three times repeatedly, confirming that your TERRANO XT is on.

To switch your unit off:

- Tap  and . 

In all battery states, the LED flashes red three times repeatedly, confirming that your TERRANO XT is switching off. The speaker plays a descending tone and a voice message "Goodbye".

Connecting your unit to a charger switches off the unit.

3.3 DIFFERENT WAYS TO OPERATE YOUR TERRANO XT

You can operate the various features by any of the following methods:



- Pressing a button or combination of buttons on the unit.
- Using the Voice-Assisted Menu in combination with either unit buttons or with the VOX (voice activation). VOX is for hands free operation of your TERRANO XT. You can say a word or phrase loudly when the voice-assisted menu reaches the function you want to use and your TERRANO XT performs that function.

LEDs, tones and voice announcements guide you while using the functions of your TERRANO XT, as described in [TERRANO XT Modes and Events - LED Indications](#) on page 22.

This manual describes the most direct method to operate each feature.



3.4 BASIC FUNCTIONS

To turn the volume up for current audio source:

- Tap  . 

With each tap, a louder tone is played on the speaker until you reach the maximum volume, as indicated by the maximum volume tone.

To turn the volume down for current audio source:

- Tap  . 

With each tap, a quieter tone is played on the speaker until you reach the minimum volume, as indicated by the minimum volume tone.

To mute the microphone completely and lower the speaker volume to the minimal level when an audio source is active:

- Tap  and  . 

A descending tone is played on the speaker.



3.5 PAIRING YOUR UNIT TO BLUETOOTH DEVICES

Your TERRANO XT has two Bluetooth channels for connection to Bluetooth devices such as mobile phones, GPS devices and Bluetooth music players with A2DP.

To connect your TERRANO XT to a Bluetooth device, you must first pair them while in Standby (see [TERRANO XT Modes and Events - LED Indications](#) on page 22). Once paired, they automatically recognize each other whenever they are within range.

To pair Bluetooth channel 1 to a mobile phone:

1. Enable Bluetooth on the mobile phone.

2. Press  for **5 seconds**. 

The LED flashes red and blue.

3. On your mobile phone, search for Bluetooth devices as described in your phone's instructions.

4. When your TERRANO XT appears in the list of available devices, select it.
If prompted for a PIN or Passkey, enter 0000 (four zeros).

The phone confirms that pairing has succeeded and the LED flashes purple for 2 seconds.

To pair Bluetooth channel 2 to another Bluetooth device:



1. Enable Bluetooth on the device (such as mobile phone, GPS device, music player).

2. Press  for **5 seconds**. 

The LED flashes red and blue.

3. Tap  twice. The LED starts flashing red and green.

If you are pairing a GPS device, make sure you perform the next step.

4. If you are pairing a GPS device, tap  .
The LED flashes slower.
5. On the device you are pairing, search for Bluetooth devices (as described in its instructions).
6. When your TERRANO XT appears in the list of available devices, select it.
If prompted for a PIN or Passkey, enter 0000 (four zeros).
The device confirms that pairing has succeeded and the LED flashes purple for 2 seconds.

- If pairing is not completed within 2 minutes, the unit automatically returns to Standby.
- If you have paired two different mobile phones directly to your TERRANO XT, set one as default for making calls (see [Setting the Default Mobile Phone](#) on page 17).
- Not all Bluetooth mobile phones broadcast Bluetooth Stereo music (A2DP), even if the phone has an MP3 player function. Consult your mobile phone's user manual for more information.
- Not all Bluetooth GPS devices allow connection to Bluetooth audio devices. Consult your GPS User Manual for more information.

To cancel the pairing process:

- Press  for **2 seconds**. 
- The LED stops flashing red and blue or red and green.

To reset all Bluetooth device pairing:

- Press  and  for **5 seconds**. 
- In all battery states, the LED flashes purple slowly five times, confirming that pairing has been reset.

Resetting all Bluetooth device pairing also resets all Bluetooth intercom pairing.

4. ON THE ROAD

4.1 MAKING AND RECEIVING PHONE CALLS

You can use your mobile phone normally to make and receive phones while paired to your TERRANO XT.

4.1.1 MAKING PHONE CALLS

You cannot make phone calls during mobile or Bluetooth intercom 3 or 4-way calls.

To make a phone call through the unit buttons:

- To dial the default speed dial number, tap  **3 times**.



- To redial the last number called, press  for **2 seconds**.



4.1.2 ANSWERING PHONE CALLS

To answer a phone call:

- Tap  or .

4.1.3 REJECTING PHONE CALLS

To reject a phone call :

- Press  for **2 seconds**.

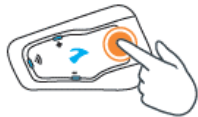

4.1.4 ENDING PHONE CALLS

To end a phone call:

- Tap .



4.1.5 TOGGLING BETWEEN CALLS ON TWO MOBILE PHONES PAIRED TO YOUR UNIT

Your TERRANO XT can toggle between two calls on two mobile phones when both mobile phones are paired to your unit.

To toggle between two calls:

- Tap  twice.

4.1.6 DISCONNECTING THE CURRENT CALL AND SWITCHING TO THE SECOND CALL

You can disconnect the current call and switch to the call on the second phone when two mobile phones are paired to your unit.

To disconnect the current call and switch to the second call:

- Tap .

4.2 BLUETOOTH INTERCOM

To connect your unit to another unit with a Bluetooth intercom, you must first pair their channels. Once paired, the units automatically recognize each other whenever they are in range (line of sight up to 1.2 km / 3,900 ft subject to terrain).

- Pairing a channel replaces any existing paired device on that channel with the new device.



4.2.1 PAIRING THE BLUETOOTH INTERCOM TO OTHER TERRANO UNITS



To pair your unit with another Terrano unit:

1. Confirm your unit is in Standby mode (LED flashes slowly).
2. On your unit, press  for **5 seconds**.



The LED flashes red.

3. Select the Bluetooth intercom channel you would like to pair:
 - Channel A - do not tap anything (default channel).
 - Channel B - tap  twice. The LED flashes blue.
 - Channel C - tap  three times. The LED flashes purple.
4. On the other Terrano unit, activate Bluetooth intercom pairing mode (see the other Terrano unit user manual at terranosystems.com/support).
5. The unit confirms that pairing has succeeded and the LED flashes purple for 2 seconds.

- To cancel the pairing process, press  for 2 seconds. The LED stops flashing.
- If pairing is not completed within 2 minutes, the unit automatically returns to Standby.
- To reset all Bluetooth intercom pairing while in Bluetooth intercom pairing mode:
 - Press  and  for 2 seconds. The LED flashes purple 5 times slowly, confirming that pairing has been reset.

4.2.2 3-WAY AND 4-WAY BLUETOOTH INTERCOM CALLS

In addition to standard 2-way Bluetooth intercom calls, you can use the TERRANO XT for 3-way and 4-way Bluetooth intercom calls on Terrano devices. TERRANO XT allows full-duplex Bluetooth intercom communication for up to 4 riders to communicate up to 1.2 km / 3,900 ft in line of sight (subject to terrain).

In a 3-way Bluetooth intercom call, you are connected to two riders, and each of those riders are connected only to you. You can call either of the two. If you are already in a Bluetooth intercom call with one rider, just add another. All three riders are now connected in a 3-way Bluetooth intercom call.



In a 4-way intercom conference call, for example, you are connected to three riders, who may also be connected to an additional rider. You are directly connected to Rider 1 and Rider 2, and connected to Rider 3 through Rider 2's free channel. All four riders are now all connected in a 4-way Bluetooth intercom call.

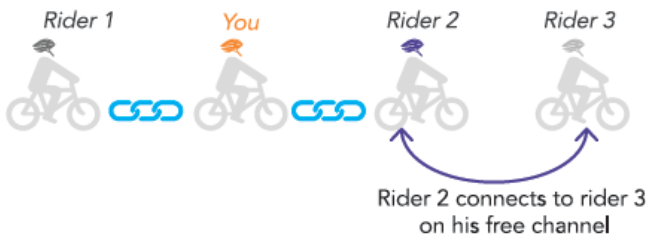

Terrano recommends that during a 3-way or 4-way intercom conference call, riders be connected to only one Bluetooth intercom call so they can continue to hear mobile phone and GPS announcements.

Using parallel audio streaming, you can also speak on a 3-way or 4-way Bluetooth intercom call while listening to FM radio. The Bluetooth intercom volume remains the same while the FM radio plays at a reduced volume in the background.





For information on making Bluetooth intercom calls, see [Using the Bluetooth Intercom](#) on page 11

4.2.3 USING THE BLUETOOTH INTERCOM

- To make and receive Bluetooth intercom calls, you must first pair the Bluetooth, see [Bluetooth Intercom](#) on page 10.
- During a 3 or 4-way Bluetooth intercom conference call while riders are in range (1.2 km / 3,900 ft), riders using both Bluetooth intercom channels cannot receive phone calls or GPS instructions while the call is in progress.

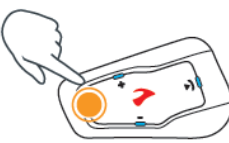
4.2.3.1 STARTING/ENDING BLUETOOTH INTERCOM CALLS



To start or end a Bluetooth intercom call:

- 
- To start a call on Channel A, tap .
 - To start a call on Channel B, tap  **2 times**.
 - To start a call on Channel C, tap  **3 times**.

If Channels A and B are connected, VOX opens a Bluetooth intercom 3-way call.

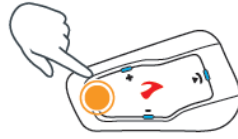
To end a Bluetooth intercom call:



- To disconnect Channel A, tap .
- To disconnect Channel B, tap  **2 times**.
- To disconnect Channel C, tap  **3 times**.

If you initiated the Bluetooth intercom call using [VOX](#) and remain silent for at least 30 seconds, the call ends.



4.2.3.2 MAKING 3-WAY OR 4-WAY BLUETOOTH INTERCOM CALLS

For recommendations on making Bluetooth intercom 3-way and 4-way calls and pairing units for Bluetooth intercom calls, see [Bluetooth Intercom](#) on page 10.

To initiate a 3-way Bluetooth intercom call:

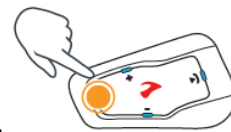

- Start a conference call:
 - To start a call on Channels A and B, press  for **2 seconds**.



- To start a call on Channel A or add Channel A to a call, tap  once.
- To start a call on Channel B or add Channel B to a call, tap  **2 times**.
- To start a call on Channel C or add Channel C to a call, tap  **3 times**.

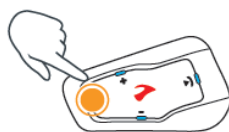



To start a 4-way Bluetooth conference call:



1. Press  for **2 seconds**.
A Bluetooth intercom 3-way call with Rider 1 and Rider 3 starts.
2. Rider 2 taps . Rider 3 is added to the Bluetooth intercom call.



To end a Bluetooth intercom call:

- To disconnect rider on channel A, tap .
- To disconnect rider on channel B, tap  **2 times**.
- To disconnect rider on channel C, tap  **3 times**.
- To end all active Bluetooth intercom connections, press  for **2 seconds**.

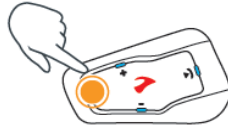

4.2.3.3 BLUETOOTH INTERCOM BUSY SIGNAL

A busy signal is heard when you attempt a Bluetooth intercom call when the other rider is in a:

- Phone call
- Bluetooth intercom call with Channels A and B

4.3 LISTENING TO MUSIC AND RADIO

4.3.1 LISTENING TO MUSIC

To start music streaming from your paired device:

- Tap  . 

To stop music streaming:

- Press  for **2 seconds**.

To skip to the next track (while streaming music):

- Tap .



To skip to the previous track (while streaming music):

- Tap  **2 times**.

To forward auto-scan tracks (while streaming music) and play a track:

1. Tap  and  . 

Forward scan plays a few seconds of each track.

2. When you hear a track that you want to play, tap  . 

To backward auto-scan tracks (while streaming music) and play a track:

1. Tap  and .

2. When you hear a track that you want to play, tap .

4.3.1.1 SWITCHING MUSIC SOURCES

If two music (A2DP) audio sources are paired, TERRANO XT uses the audio source from which you last played music.

To switch to the other audio source:

1. Stop music (A2DP) playback from the current device (see [Listening to Music](#) on page 13).
2. Play music (A2DP) from the other device (see [Listening to Music](#) on page 13).

TERRANO XT automatically remembers your last played device.

4.3.2 LISTENING TO FM RADIO

To turn on the FM radio:

- Tap  **2 times**. 

When you switch on your FM radio, the station that was playing when you last switched off resumes playing.

To turn the FM radio off:

- Press  for **2 seconds**.



To play a different preset station:

- Tap  for the next preset or tap  twice for the previous preset.

To scan for and select a station:

1. Tap  and . 

The FM radio plays each station that it finds for several seconds.

2. When you hear a station you want to select, tap . 



To store a scanned station in the active preset:

- Tap  within 20 seconds of stopping the scan.

Temporarily Storing New FM Radio Stations Using Auto Tuning

You can temporarily store new FM radio stations in the presets using auto tuning and restore the original presets when you want.

To temporarily store new stations in the presets (auto tuning):

- Press  for 5 seconds. 

To restore the original presets (following auto tuning):

- Switch your unit off, then turn it back on.



4.3.3 SHARING MUSIC AND RADIO

You can share music and FM radio with another rider.

- Music and radio can be shared with only one rider.
- Music sharing is possible within a limited range.
- Bluetooth intercom calls are disabled when sharing music.
- FM radio sharing opens a Bluetooth intercom call automatically.
- While sharing music, you cannot use Bluetooth intercom.
- If you paired your unit to two mobile phones, music will be shared from the mobile phone through which you last played music.
- When sharing FM radio, either rider can change station while the Bluetooth intercom call remains open.
- When you stop sharing FM radio, the Bluetooth intercom call remains open and the FM radio continues to play independently on each rider's unit.
- When stop music sharing, music continues on your unit only.

To start/stop sharing:

1. Confirm your TERRANO XT is in Standby mode (LED flashes slowly).
2. Start playing music or the FM radio.

3. Press  for 2 seconds to start sharing on Channel A (by default). 

To share music or radio on other channels:

1. Start playing music or the FM radio.
2. Start a Bluetooth intercom call on the desired channels (A, B or C).
3. Press  for 2 seconds.

- d. To stop sharing, press  for 2 seconds.

5. PERSONALIZING YOUR DEVICE

Get the most out of your TERRANO XT by changing the settings and customizing your unit according to your own personal preferences, using either of the following methods:

- Terrano Connect on Windows / Mac - minimum requirements - Windows® 7 / Mac OS X 10.8
- Unit buttons.
- Configuration voice menu on your device.

Terrano recommends customizations and settings before getting out on the road.

Object	Default Value	Description	Configuration Voice Menu
Audio priority (A2DP/Bluetooth intercom)	Bluetooth intercom	Priority of audio source playing through speakers. Either music is not interrupted by an intercom call, or vice-versa.	✓
Background Audio Level	N/A	Sets the background audio volume when parallel audio streaming is on (see Parallel audio streaming (Enable/Disable) below).	✗
Bluetooth friendly name	TERRANO XT	Sets the name that appears on your phone while pairing.	✗
FM Band	According to Your Region	If you are in Japan, select Japan . Otherwise, select Worldwide .	✗
Gain Control	Medium	Adjusts speaker volume according to ambient noise and riding speed. For example, when set to Low, higher ambient noise will cause the volume increase to kick in at a higher level.	✓
Language	According to Your Region	Voice announcements and voice-assisted menus language (see "Spoken Status Announcements" below).	✓
Mobile priority	Mobile 1	If you paired your unit to two mobile phones, you must set one of them as the default phone for outgoing calls.	✗
Parallel audio streaming (Enable/Disable)	Enable	You can hear two audio sources simultaneously. For example, hear GPS while listening to music. <div style="border: 1px solid black; padding: 2px; margin-top: 5px;">Limitations may apply when using certain iOS devices.</div>	✓
RDS (Enable/Disable)	Disable	Radio Data System allows the radio to automatically retune to the strongest frequency available for the FM station you are listening to when the signal becomes too weak.	✓
Set speed dial numbers	Empty	Pre-set phone numbers for automatic dialing.	✗
Set the six FM radio presets	107.5	Pre-set FM radio stations.	✗
Spoken Status Announcements (Enable/Disable)	Enable	Voice announcements inform you to whom or to what device you are connected.	✓
VOX activation (Enable/Disable)	Enable	Enables voice activation of certain features for hands-free operation.	✓
VOX sensitivity (Low/Medium/High)	Medium	Adjusts your microphone sensitivity for voice activation while riding. For example, in high ambient noise situations, setting VOX sensitivity to low requires speaking loudly. <div style="border: 1px solid black; padding: 2px; margin-top: 5px;">You can set the microphone sensitivity (high, medium, or low) to better fit your voice profile in the Audio settings in the Terrano Connect app.</div>	✓

5.1 SETTING THE DEFAULT MOBILE PHONE

If you paired your unit to two mobile phones, you must set one of them as the default phone for outgoing calls.

To set the default phone:

- During a mobile call, press  for **5 seconds**.



5.2 USING PARALLEL AUDIO STREAMING

With parallel audio streaming, you can hear audio instructions during a mobile or Bluetooth intercom call, or while listening to other audio sources, such as music or FM radio.

Limitations may apply when using certain iOS devices.

Your TERRANO XT sets the various audio sources to either foreground (volume remains the same) or background (volume reduced) as described in the following table:

Mobile Phone 1/2	Audio Instructions	Intercom 1	Intercom 2	Music	FM Radio
Foreground	Foreground				
Foreground ¹		Foreground ¹			
	Foreground	Foreground			
	Foreground			Background	
	Foreground				Background
		Foreground		Background	
		Foreground			Background
		Foreground ^{2,3}	Foreground ^{2,3}		Background
				Foreground ⁴	
					Foreground ⁵

¹If you add an intercom call to a mobile phone call creating a conference call, the volume for both audio sources is the same.

²If you make two intercom calls simultaneously creating an intercom conference call, the volume for both audio sources is the same.

³If you make two intercom calls simultaneously creating an intercom conference call, you cannot hear the mobile phone or audio instructions.

⁴If you play music only, the music volume is not reduced.

⁵If you play the FM radio only, the FM radio volume is not reduced.

In some cases, parallel audio streaming may not work properly due connected device limitations (music player or GPS navigator).

Terrano recommends that during a 3-way or 4-way Bluetooth intercom conference call, the rider who is connected to only one intercom call listens for mobile phone and GPS announcements.

You cannot use music sharing for voice audio with riders during parallel audio streaming.

5.3 AUDIO SOURCE PRIORITIES

If Parallel Audio Streaming is disabled, TERRANO XT manages the audio sources you hear through the speakers according to the following audio source priorities.

Priority	Audio Source
Higher Priority	Mobile phone, GPS device instructions
↑	Intercom or Music ¹
Lower Priority	Music or Intercom FM Radio

¹When audio priority is set to Intercom, you cannot hear navigation app or SMS messages from your phone during an ongoing intercom call.

²When audio priority is set to A2DP (music), the intercom is disabled while listening to music (via A2DP). A rider calling you by intercom hears a sound indicating you are not available.

- Intercom modes all have the same priority, so ongoing intercom calls will not be interrupted by any other intercom call.

If you paired your unit to two mobile phones (see [Setting the Default Mobile Phone](#) on page 17), music will be shared from the mobile phone through which you last played music.

When sharing FM radio (see [Sharing Music and Radio](#) on page 15), either rider can change station and Intercom.

6. TROUBLESHOOTING

6.1 SOFT RESET

If your TERRANO XT stops responding, reset it by either:

- Turning it off and then on again (see [Switching Your Unit On/Off](#) on page 6).
- Using the supplied USB cable, connect your computer or wall charger to the TERRANO XT USB port for 30 seconds.

6.2 RESET PAIRING

This option deletes all paired units and devices.



To reset pairing:

- Press  and  for 5 seconds.

6.3 RESET TO FACTORY SETTINGS

This option deletes all paired units, devices and all configuration settings.

To perform a factory reset:

1. Check that your TERRANO XT is in Standby mode (see [TERRANO XT Modes and Events - LED Indications](#) on page 22).
2. Simultaneously press  +  +  for 5 seconds.

6.4 FAQ

Additional answers to common problems can be found at www.terranosystems.com/support.

7. SUPPORT

For additional information:

 www.terrano.com

 support@terrano.com

Multinational E-commerce companies and online auction websites are not authorized to sell Terrano products and purchases from such sites are at your own risk. To receive warranty or customer service, you must submit original receipts from authorized Terrano dealers.

Products that were imported from North America must be serviced in the USA.

8. GLOSSARY

Term/Abbreviation	Description
A2DP	Advanced Audio Distribution Profile (for music). A protocol for playing music over Bluetooth.
IC	Intercom.
Language	Voice announcements and voice-assisted menus language.
RDS	Radio Data System allows the radio to automatically retune to the strongest frequency available for the FM station you are listening to when the signal becomes too weak.
VOX	Voice activation (by saying a word or phrase loudly) of certain features for hands-free operation.
VOX sensitivity	Adjusts your microphone sensitivity for voice activation while you are riding.
Unit	TERRANO XT device.
Device	Mobile phone, GPS or music player.

APPENDIX A. TERRANO XT MODES AND EVENTS - LED INDICATIONS

Your TERRANO XT operates in various modes. Each mode consists of a group of features currently available for your use. For example, when TERRANO XT plays music, it will be in music playing mode, enabling features related to playing music such as skipping to the next and previous tracks.

"Events" are considered to occur whenever you operate a feature and when TERRANO XT's responds. For example, turning on music is an "event".

TERRANO XT's current mode is indicated by the unit LEDs. You also hear voice announcements on your unit for mode changes and events.

The following table shows LED indications for modes and events according to the current battery state.

LED	Flashing	Battery State	Mode or Event
Blue	For 2 seconds	Normal	<ul style="list-style-type: none"> Rider B connected Set VOX to enabled
Blue	Fast (3 times)	Normal Low Battery Charging	<ul style="list-style-type: none"> Power on
Blue	Fast (repeating fast)	Normal, Low Battery Charging	<ul style="list-style-type: none"> Pairing intercom rider B
Blue	Slow (repeating every 3 seconds)	Normal	<ul style="list-style-type: none"> Standby
Blue	Slow twice (repeating slowly every 3 seconds)	Normal	<ul style="list-style-type: none"> Incoming/outgoing call (intercom or mobile) Audio active (intercom, FM, A2DP, GPS, Feature/Settings menu)
Off	Off	Normal Low Battery	<ul style="list-style-type: none"> Off
Purple	Fast (repeating fast)	Normal Low Battery Charging	<ul style="list-style-type: none"> Pairing intercom rider C
Purple	For 2 seconds	Normal Low Battery Charging	<ul style="list-style-type: none"> Mobile pairing successful Mobile connected Rider C connected GPS pairing successful/connected
Purple	Slow (5 times)	Normal Low Battery	<ul style="list-style-type: none"> Reset pairing
Purple/Red	Purple twice slowly and red on	Charging	<ul style="list-style-type: none"> Incoming/outgoing call (intercom or mobile) Audio active (intercom, FM, A2DP, GPS, Feature/Settings menu)
Purple/Red	Slow purple and red (repeating)	Charging	<ul style="list-style-type: none"> Standby
Red	Slow twice (repeating slowly every 3 seconds)	Low Battery	<ul style="list-style-type: none"> Incoming/outgoing call (intercom or mobile) Audio active (intercom, FM, A2DP, GPS, Feature/Settings menu)
Red	Fast (repeating slowly every 3 seconds)	Low Battery	<ul style="list-style-type: none"> Standby
Red	Fast (repeating fast)	Normal Low Battery Charging	<ul style="list-style-type: none"> Pairing intercom rider A
Red	Fast (3 times)	Normal Low Battery Charging	<ul style="list-style-type: none"> Power off

LED	Flashing	Battery State	Mode or Event
Red	For 2 seconds	Normal Low Battery Charging	<ul style="list-style-type: none"> Rider A connected Set VOX to disabled
Red	Remains on	Charging	<ul style="list-style-type: none"> Off
Red/Blue	Alternating fast	Normal Low Battery Charging	<ul style="list-style-type: none"> Pairing Mobile 1
Red/Blue	Alternating slow	Normal Low Battery	<ul style="list-style-type: none"> Pairing GPS 1
Red/Green	Alternating fast	Normal Low Battery Charging	<ul style="list-style-type: none"> Pairing Mobile 2
Red/Green	Alternating slow	Normal, Low Battery	<ul style="list-style-type: none"> Pairing GPS 2
Yellow	Fast (repeating)	Normal Low Battery Charging	<ul style="list-style-type: none"> Incoming/outgoing connection
Yellow	For 2 seconds	Normal Low Battery Charging	<ul style="list-style-type: none"> Intercom call attempted without microphone or audio kit connected.

© 2018 Terrano Systems

All rights reserved. Terrano, the Terrano logo and other Terrano marks are owned by Terrano and may be registered. All other trademarks are the property of their respective owners. Terrano Systems assumes no responsibility for any errors that may appear in this document. Information contained herein is subject to change without notice.